

ARMÁRIO AÉREO 02 PORTAS BÁSCULAS NESHER IMPERATRIZ 80 CM 100% MDF

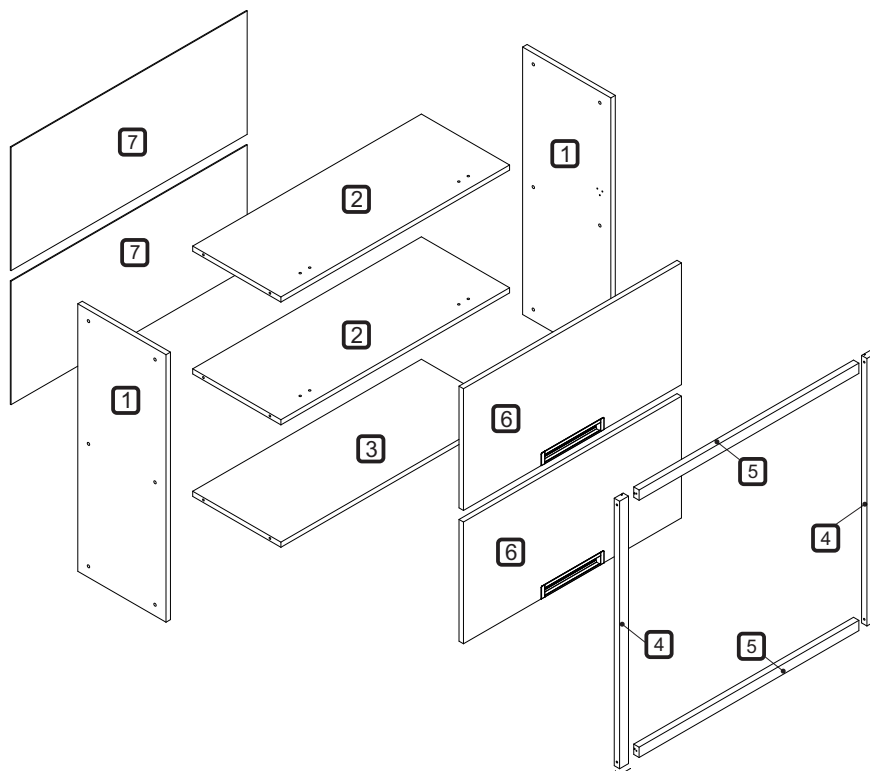

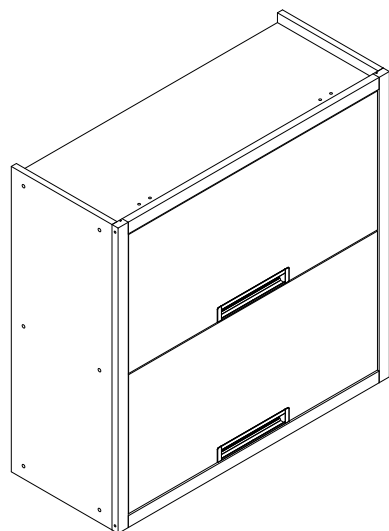

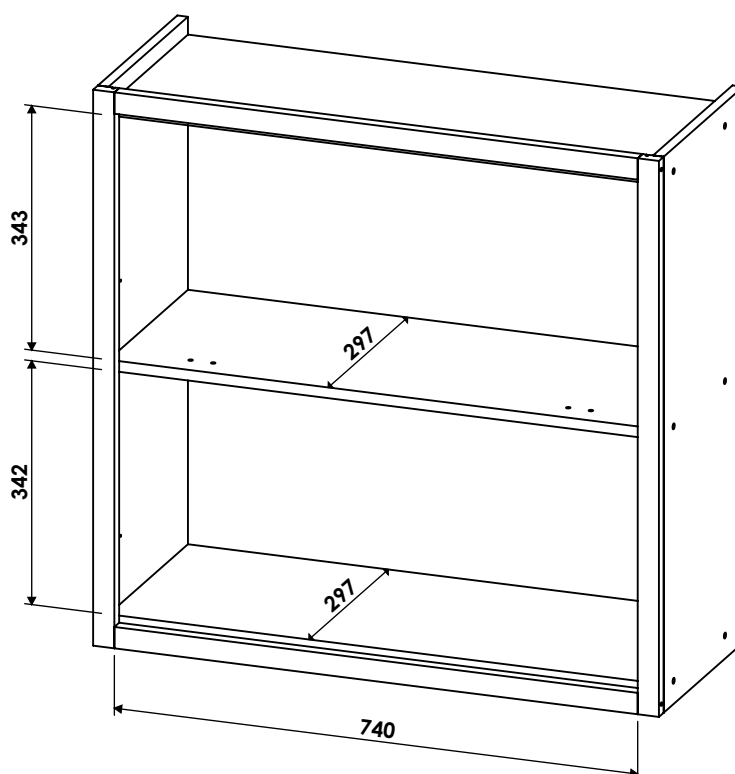

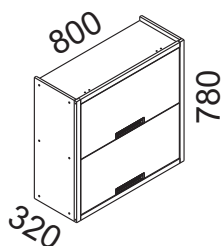

DIMENSÕES DOS ESPAÇOS INTERNOS (MEDIDAS EM MILÍMETRO)

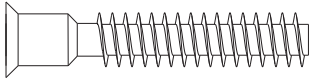
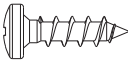
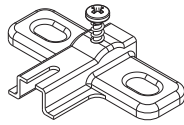
DIMENSÕES MÁXIMAS DO PRODUTO MONTADO

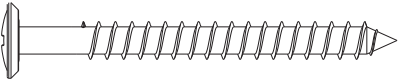
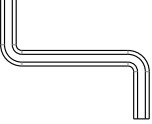
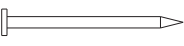
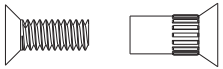
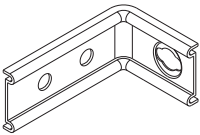
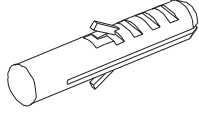
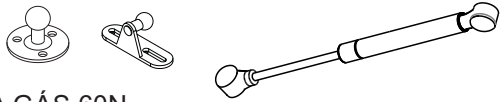
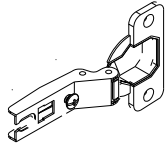

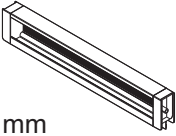
CÓDIGO	DESCRIÇÃO	QTDE	COMP.	LARG.	ESP.
1	LATERAL	2	780	297	15
2	TAMPO / PRATELEIRA	2	770	297	15
3	BASE	1	770	297	15
4	MOLDURA LATERAL	2	780	30	18
5	MOLDURA SUPERIOR INFERIOR	2	740	30	18
6	PORTA BASCULANTE	2	734	355	15
7	FUNDO TRASEIRO	2	795	363	2,5

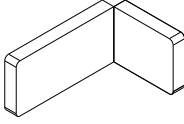
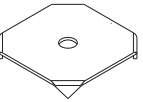
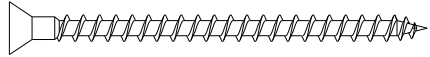
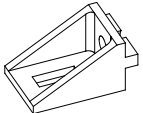
CÓDIGO/DESCRIÇÃO	QUANTIDADE	CÓDIGO/DESCRIÇÃO	QUANTIDADE
A  PARAFUSO 7x40mm CABEÇA CHATA	12	B  PARAFUSO 4x14mm CABEÇA PANELA	44
C  CALÇO PARA DOBRADIÇA 35mm	4	D  PARAFUSO UNIAO DE MÓDULOS 28MM	3
E  PARAFUSO 5x50mm CABEÇA FLANGEADA	4	F  CHAVE ZETA	1
G  PREGO 10x10 COM CABEÇA	34	H  PARAFUSO DE UNIÃO 17mm	8
I  CANTONEIRA METALICA PARA FIXAÇÃO NA PAREDE	4	J  BUCHA DE PAREDE DE 8mm	4
K  PISTÃO A GÁS 60N	2	L  DOBRADIÇA ALTA CANECO 35mm	4
M  BATENTE DE SILICONE	4	N  PUXADOR 211 mm - FURAÇÃO 160 mm	2
O  TAPA FURO ADESIVO 12mm	16	P  CAPA PLÁSTICA PARA CANTONEIRA	4
Q  FIXADOR FUNDO TRASEIRO METÁLICO	8	R  PARAFUSO 3,5X50mm CABEÇA CHATA	4
S  SUPORTE ANGULAR	12		